

## Display- programomkopplare DPS

SV Monteringsanvisning

159862-01



**Germany**  
GEZE Sonderkonstruktionen GmbH  
Planken 1  
97944 Boxberg-Schweigern  
Tel. +49 (0) 7930 9294 0  
Fax +49 (0) 7930 9294 10  
E-Mail: sk.de@geze.com  
GEZE GmbH  
Niederlassung Süd-West  
Tel. +49 (0) 7152 203 594  
E-Mail: leonberg.de@geze.com  
GEZE GmbH  
Niederlassung Süd-Ost  
Tel. +49 (0) 7152 203 6440  
E-Mail: muenchen.de@geze.com  
GEZE GmbH  
Niederlassung Ost  
Tel. +49 (0) 7152 203 6840  
E-Mail: berlin.de@geze.com  
GEZE GmbH  
Niederlassung Mitte/Luxemburg  
Tel. +49 (0) 7152 203 6888  
E-Mail: frankfurt.de@geze.com  
GEZE GmbH  
Niederlassung West  
Tel. +49 (0) 7152 203 6770  
E-Mail: essen.de@geze.com  
GEZE GmbH  
Niederlassung Nord  
Tel. +49 (0) 7152 203 6600  
E-Mail: hamburg.de@geze.com  
GEZE Service GmbH  
Tel. +49 (0) 1802 923392  
E-Mail: service-info.de@geze.com

**Austria**  
GEZE Austria  
E-Mail: austria.at@geze.com  
www.geze.at  
**Baltic States**  
GEZE GmbH Baltic States office  
E-Mail: office-latvia@geze.com  
www.geze.com  
**Benelux**  
GEZE Benelux B.V.  
E-Mail: benelux.nl@geze.com  
www.geze.be  
www.geze.nl  
**Bulgaria**  
GEZE Bulgaria - Trade  
E-Mail: office-bulgaria@geze.com  
www.geze.bg

**China**  
GEZE Industries (Tianjin) Co., Ltd.  
E-Mail: chinasales@geze.com.cn  
www.geze.com.cn  
GEZE Industries (Tianjin) Co., Ltd.  
Branch Office Shanghai  
E-Mail: chinasales@geze.com.cn  
www.geze.com.cn  
GEZE Industries (Tianjin) Co., Ltd.  
Branch Office Guangzhou  
E-Mail: chinasales@geze.com.cn  
www.geze.com.cn  
GEZE Industries (Tianjin) Co., Ltd.  
Branch Office Beijing  
E-Mail: chinasales@geze.com.cn  
www.geze.com.cn

**France**  
GEZE France S.A.R.L.  
E-Mail: france.fr@geze.com  
www.geze.fr

**Hungary**  
GEZE Hungary Kft.  
E-Mail: office-hungary@geze.com  
www.geze.hu

**Iberia**  
GEZE Iberia S.R.L.  
E-Mail: info@geze.es  
www.geze.es

**India**  
GEZE India Private Ltd.  
E-Mail: office-india@geze.com  
www.geze.in

**Italy**  
GEZE Italia S.r.l.  
E-Mail: italia.it@geze.com  
www.geze.it

GEZE Engineering Roma S.r.l.  
E-Mail: roma@geze.biz  
www.geze.it

**Poland**  
GEZE Polska Sp.z o.o.  
E-Mail: geze.pl@geze.com  
www.geze.pl

**Romania**  
GEZE Romania S.R.L.  
E-Mail: office-romania@geze.com  
www.geze.ro

**Russia**  
OOO GEZE RUS  
E-Mail: office-russia@geze.com  
www.geze.ru

**Scandinavia – Sweden**  
GEZE Scandinavia AB  
E-Mail: sverige.se@geze.com  
www.geze.se

**Scandinavia – Norway**  
GEZE Scandinavia AB avd. Norge  
E-Mail: norge.se@geze.com  
www.geze.no

**Scandinavia – Denmark**  
GEZE Danmark  
E-Mail: danmark.se@geze.com  
www.geze.dk

**Singapore**  
GEZE (Asia Pacific) Pte, Ltd.  
E-Mail: gezesea@geze.com.sg  
www.geze.com

**South Africa**  
GEZE Distributors (Pty) Ltd.  
E-Mail: info@gezesa.co.za  
www.geze.co.za

**Switzerland**  
GEZE Schweiz AG  
E-Mail: schweiz.ch@geze.com  
www.geze.ch

**Turkey**  
GEZE Kapi ve Pencere Sistemleri  
E-Mail: office-turkey@geze.com  
www.geze.com

**Ukraine**  
LLC GEZE Ukraine  
E-Mail: office-ukraine@geze.com  
www.geze.ua

**United Arab Emirates/GCC**  
GEZE Middle East  
E-Mail: gezeme@geze.com  
www.geze.ae

**United Kingdom**  
GEZE UK Ltd.  
E-Mail: info.uk@geze.com  
www.geze.com

## GEZE GmbH

Reinhold-Vöster-Straße 21–29  
71229 Leonberg  
Germany

Tel.: 0049 7152 203 0  
Fax: 0049 7152 203 310  
www.geze.com



## Varianter/Variants

Namn	Mat. nr
Displayprogramomkopplare DPS med OFF-knapp AS 500 1-facksram, alpinvit	151524
Displayprogramomkopplare DPS med OFF-knapp Nyckelbrytare SCT, 1-polig AS 500 2-facksram, alpinvit	155810
Displayprogramomkopplare DPS utan OFF-knapp AS 500 1-facksram, alpinvit	155809

## Tillbehör

Namn	Mat. nr
AS 500 UP-ram	
□ 1-fack	115376
□ 2-fack	115377
□ 3-fack	115378
□ 4-fack	115379
□ 5-fack	115380
AS 500 utanpåliggande uttag	
□ 1-fack	120503
□ 2-fack	128609
□ 3-fack	133206
Mellanram 55x55 för ST 550 alpinvit	155851
Mellanram 55x55 för LS 990 alpinvit	148997
Mellanram 55x55 för LS 990 rostfritt stål	131822
AS 500 blindlock BAB	118480
Profilhalvcylinder	090176
Brytkontakt	024467

## Passande kontaktprogram

### Jung

- AS 500
- LS 990 (med mellanram)
- ST550 (med mellanram)

### Merten

- System M

### Berker

- B3
- B7
- S1

### Gira

- Standard 55
- E2
- Event

### Feller

- EDIZIOdue

## Tekniska specifikationer

- Spänning: 24 V DC
- Strömförbrukning: 60 mA
- Ledningslängd, max.: 100 m
- Skyddsklass: IP 40
- Förvaring: -20°C - 85°C  
Ingen kondensation
- Omgivningstemperatur under drift: -15°C - 50°C
- Immunitet mot elektromagnetiska störningar enligt EN 61000-6-2

## Måttritningar

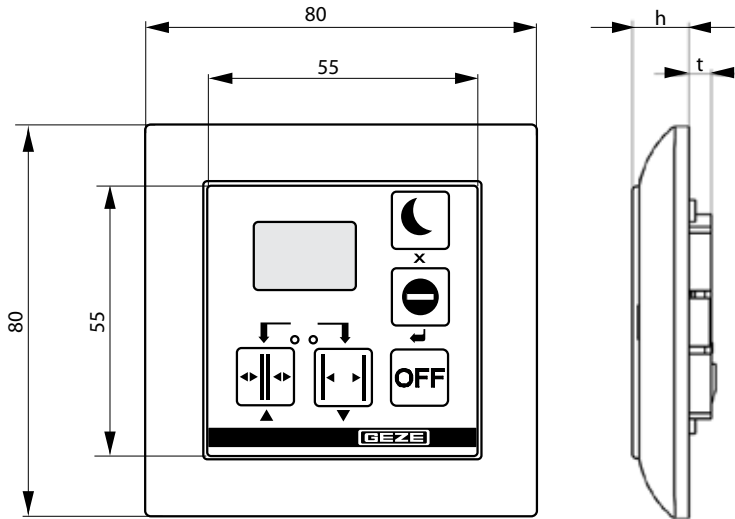

## Montering

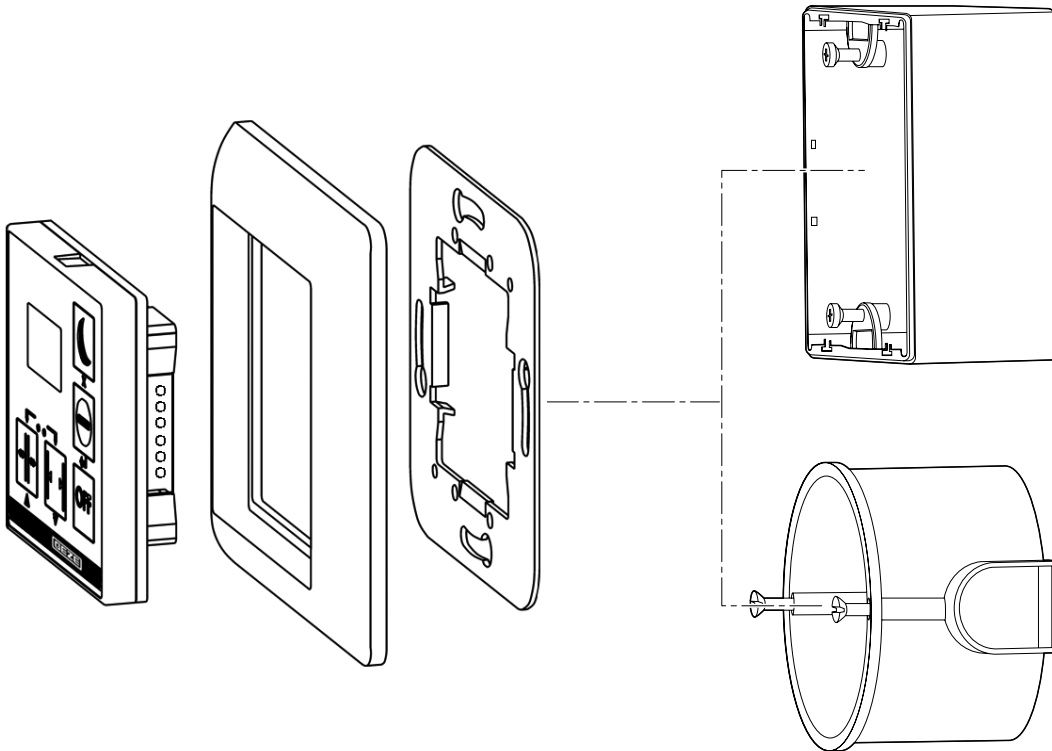

# Mall för pelarmontering

- ! Pappersmallens mått kan ändras beroende på luftfuktigheten. Endast måttuppgifterna är bindande.  
▶ Kontrollera och korrigera pappersmallens mått före användning.

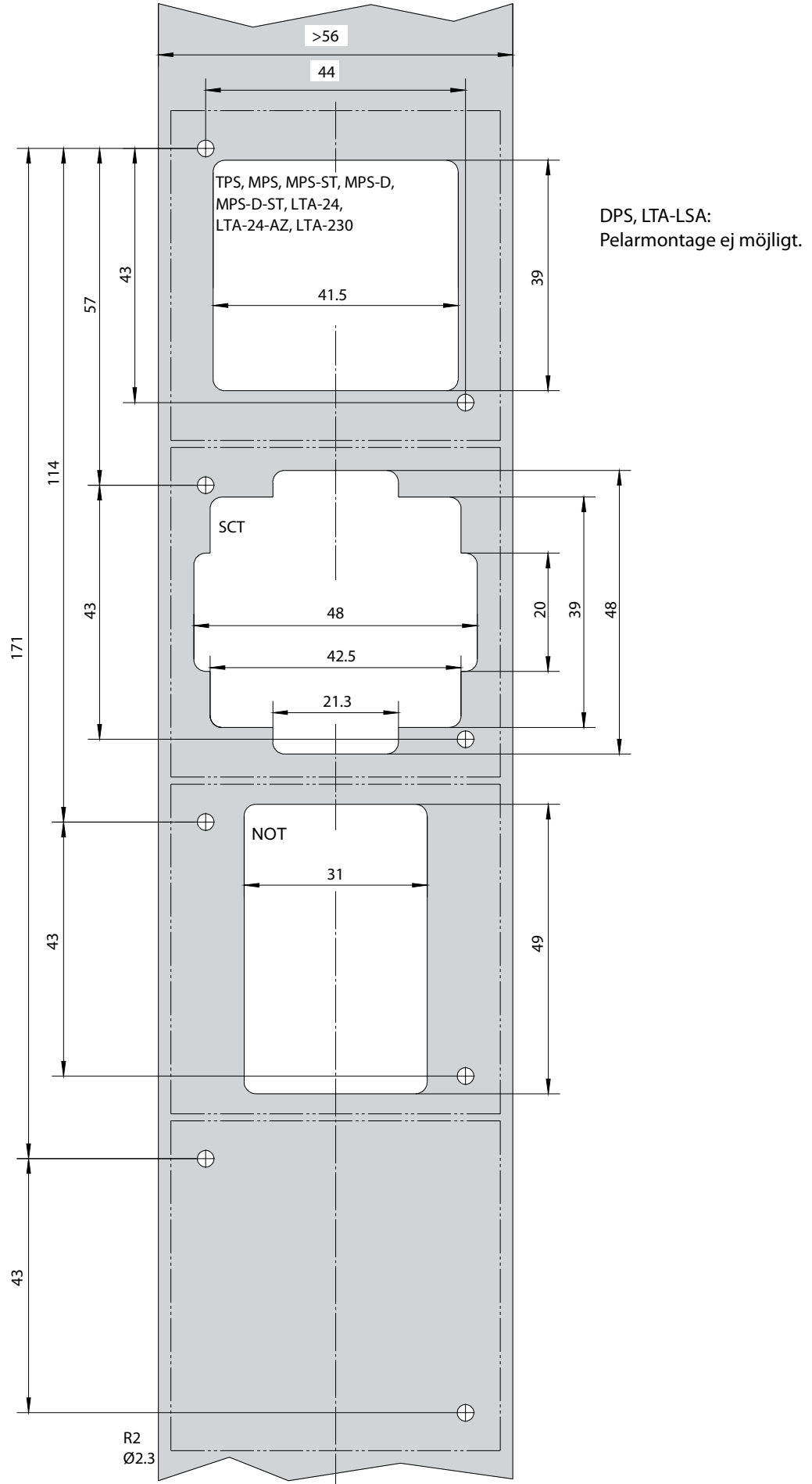

# Kopplingscheman

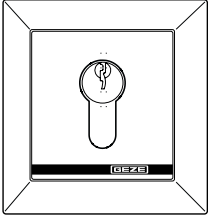
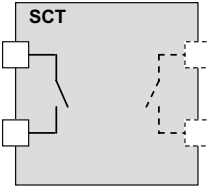
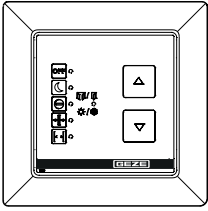
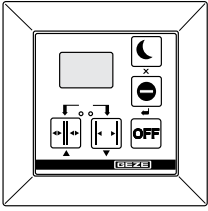
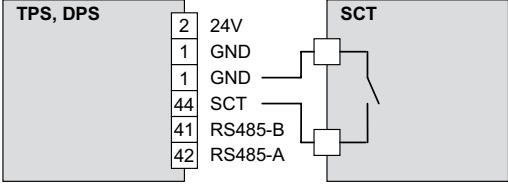
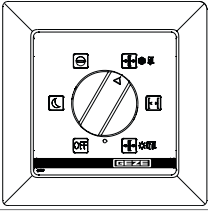
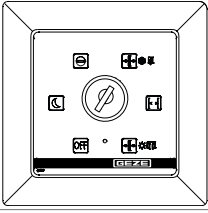
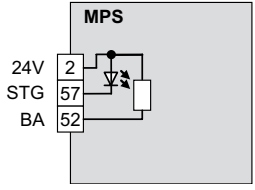
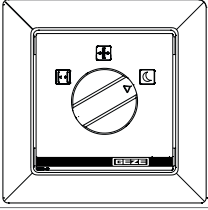
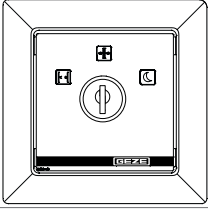
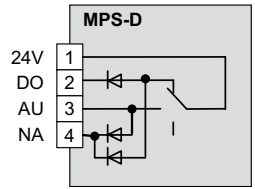
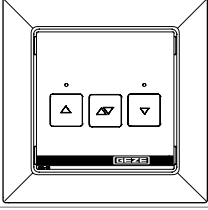
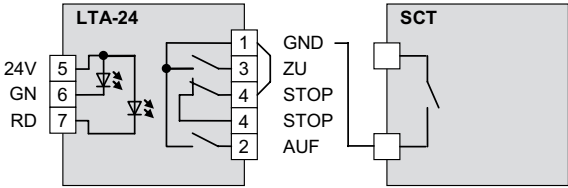
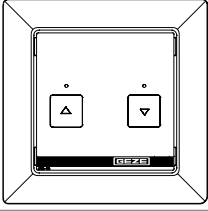
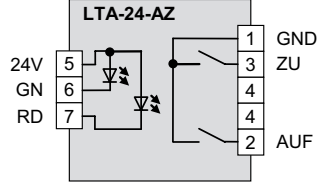
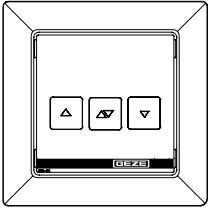
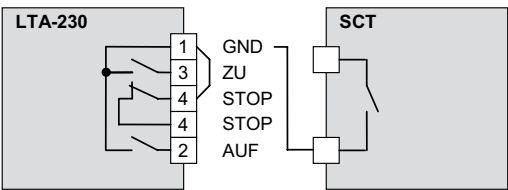
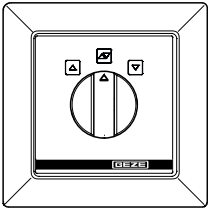
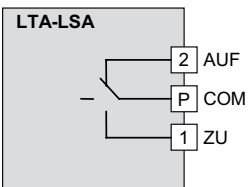
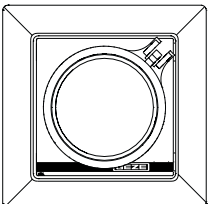
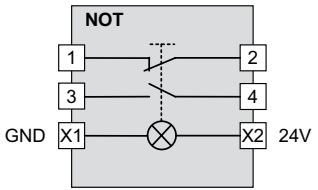
Kontakt	Beteckning	Mat. nr	Kontakt	Beteckning	Mat. nr	Kopplingschema	h [mm]	t [mm]
	SCT (1-pol.)	117996		-	-		11	31,9
	TPS TPS-SCT TPS-KDT TPS-KDT-SCT DPS med OFF DPS utan OFF DPS med OFF SCT	113231 113232 126582 126583 151524 155809 155810					11,3	5,3
	MPS	113226		MPS-ST	113227		24	36
	MPS-D	118417		MPS-D-ST	118418		24	36
	LTA-24 LTA-24-SCT	118473 127176					11	26
	LTA-24-AZ	129393					11	26
	LTA-230 LTA-230-SCT	118474 118475					11	26
	LTA-LSA	118476					24	32
	NOT	123132					54	56